

100% Design Successfully Casing

GLOBAL DESIGN TECHNOLOGY CO.,LTD

Hongkong Office: Rm 2113 , 21 Floor ,Landmark North , 39# Lung Sum
Avenue Sheung Shui ,New Territories ,HONGKONG

Factory: 2 Floor,Block A, Lihe Industrial Park,Nanshan District Shenzhen China

Tel:+00852-51018371

Contact Person:MS.Ada

Email:Ada@designcustomusb.com & MSN:Design-Ada@hotmail.com

FACTORY TOUR

Worker:100

Acreage:1000 square metre



Toing color for the casing



DESIGN CUSTOM USB

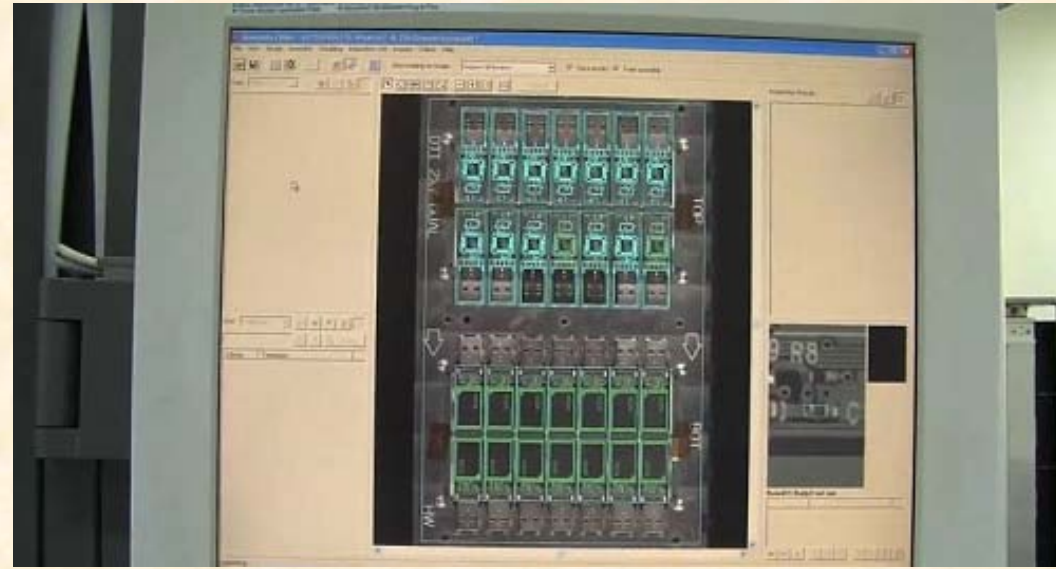



QC System



How Quick

4 weeks from start to finish

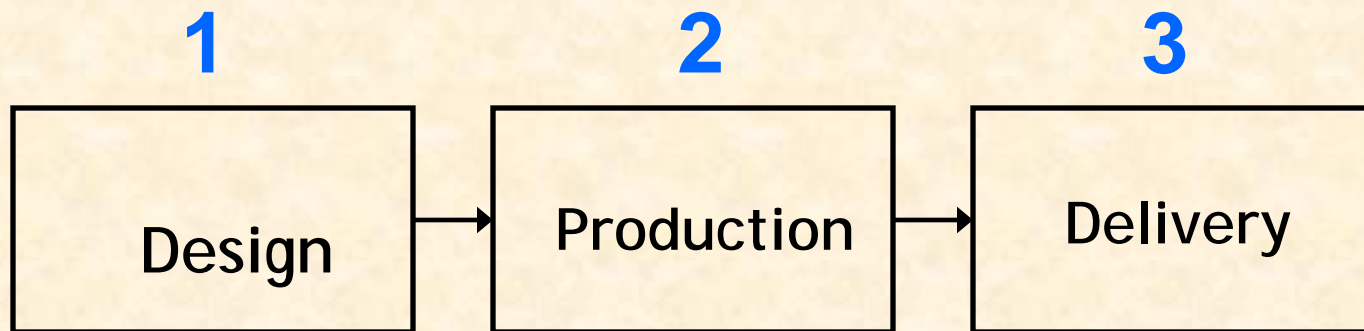

DESIGN CUSTOM
USB

100% Design Successfully casing

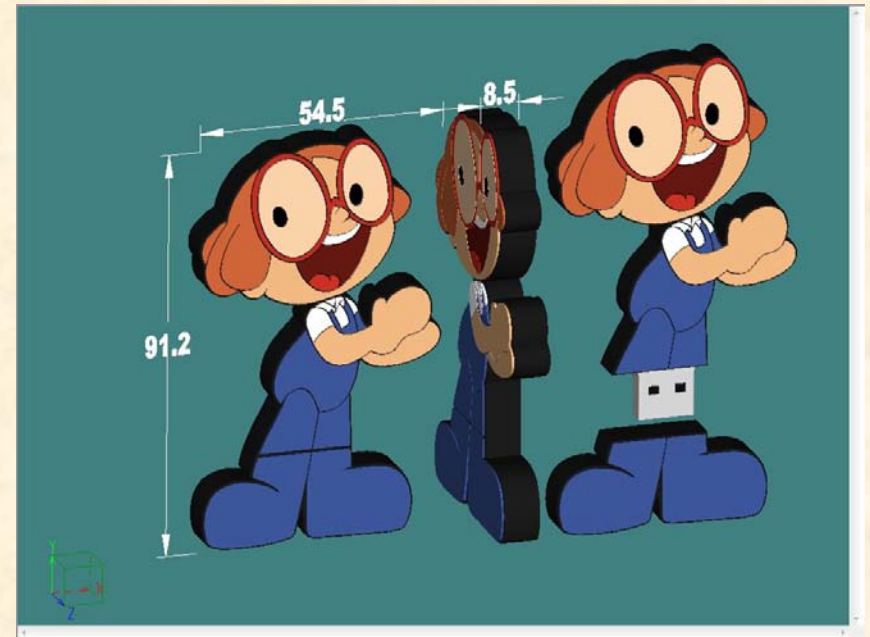
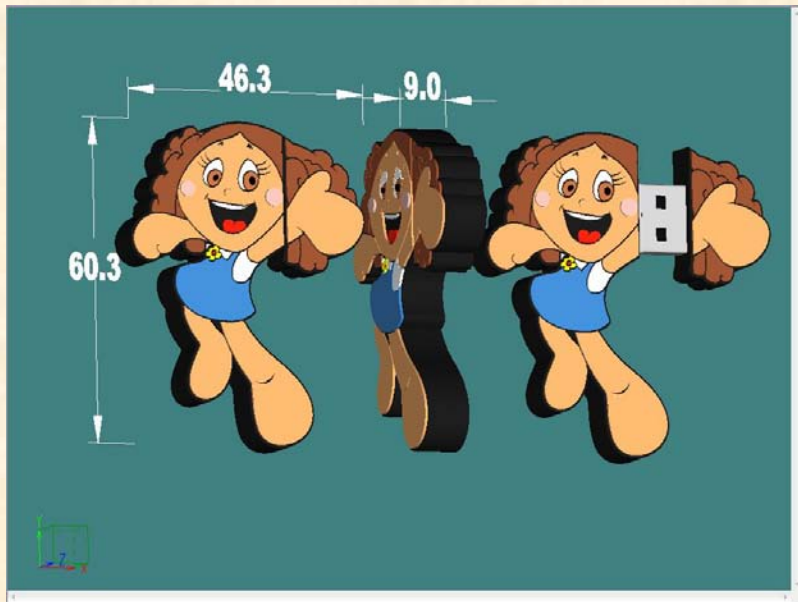

100% Design Successfully casing

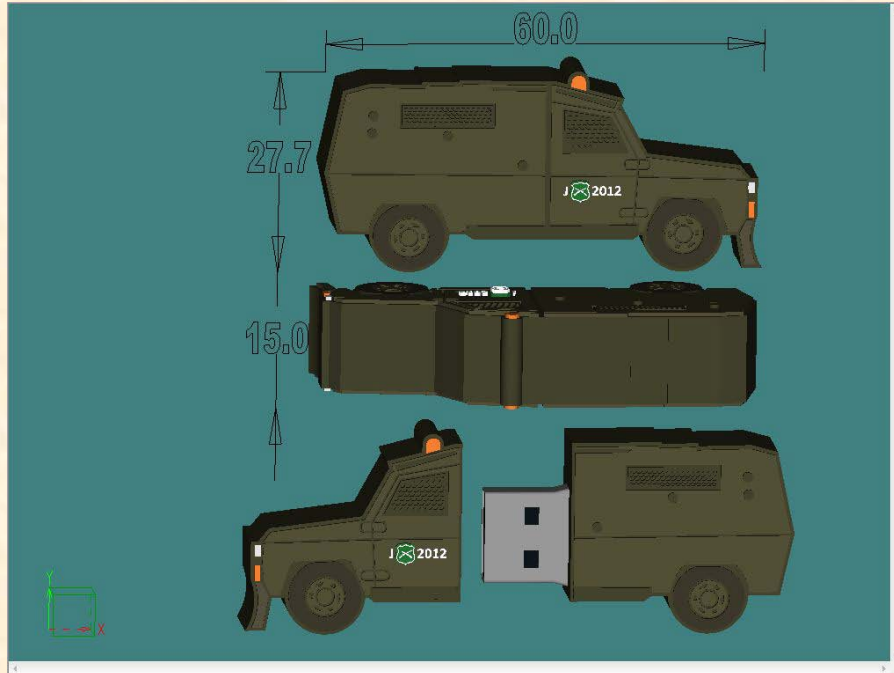

DESIGN CUSTOM
USB

100% Design Successfully casing

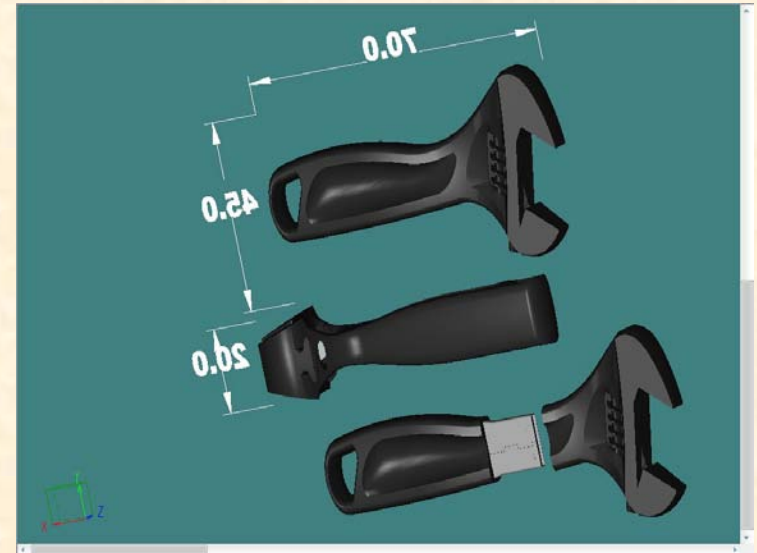
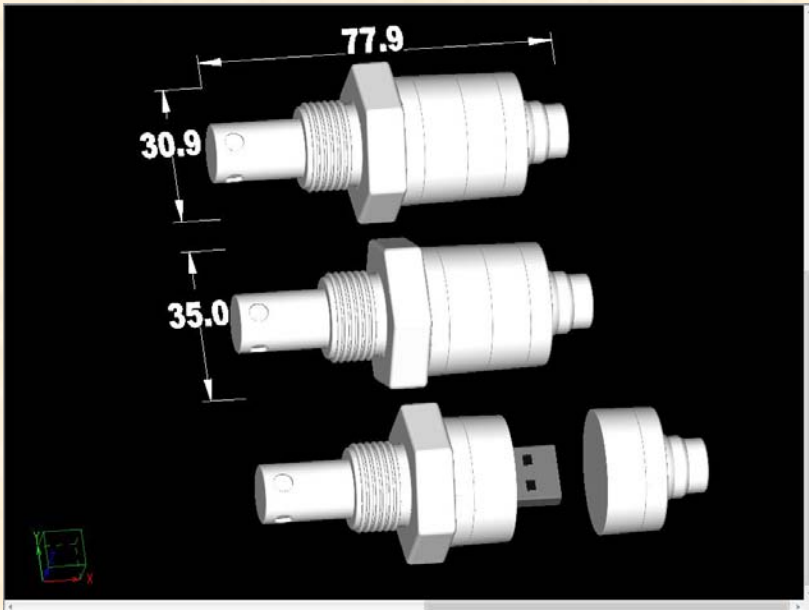

100% Design Successfully casing

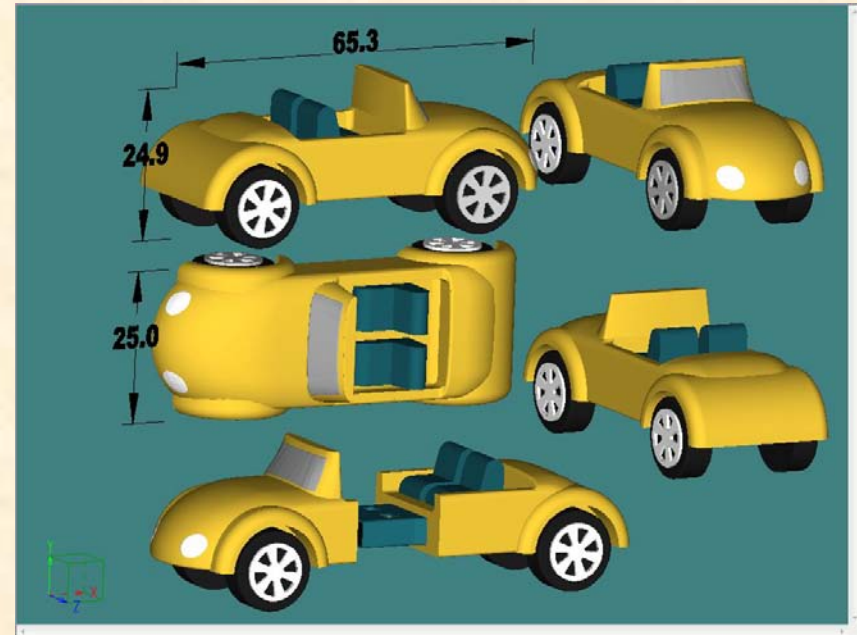
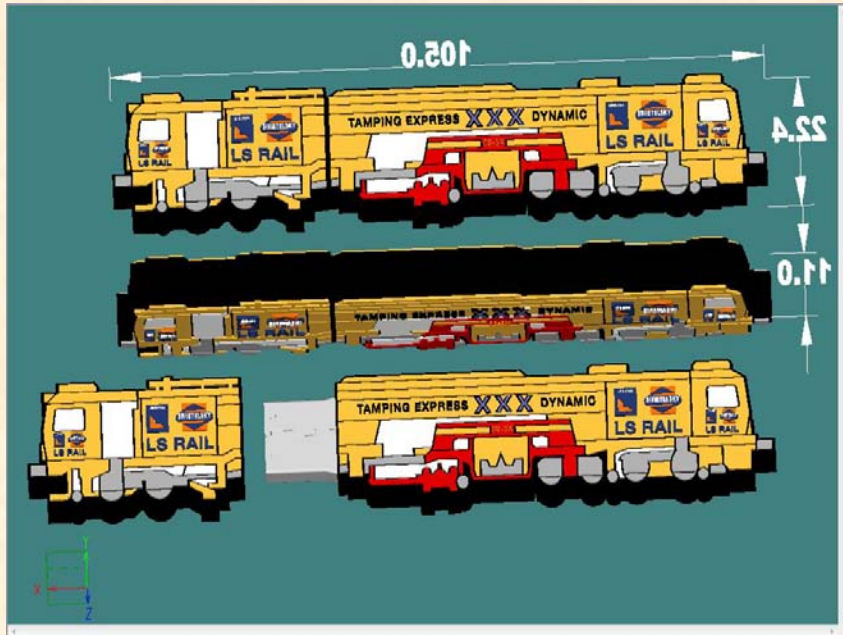

100% Design Successfully casing

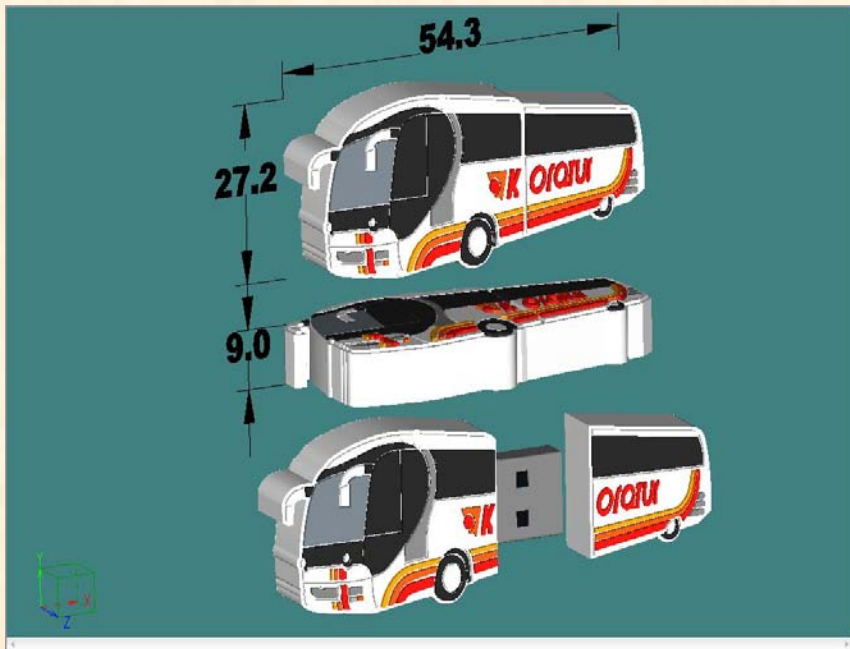

DESIGN CUSTOM
USB

100% Design Successfully casing



100% Design Successfully casing

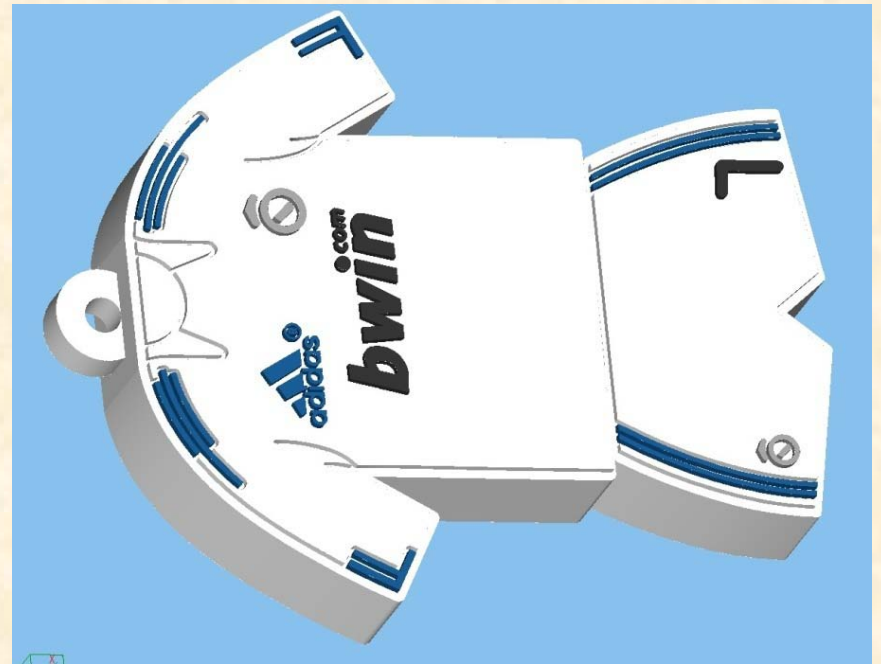
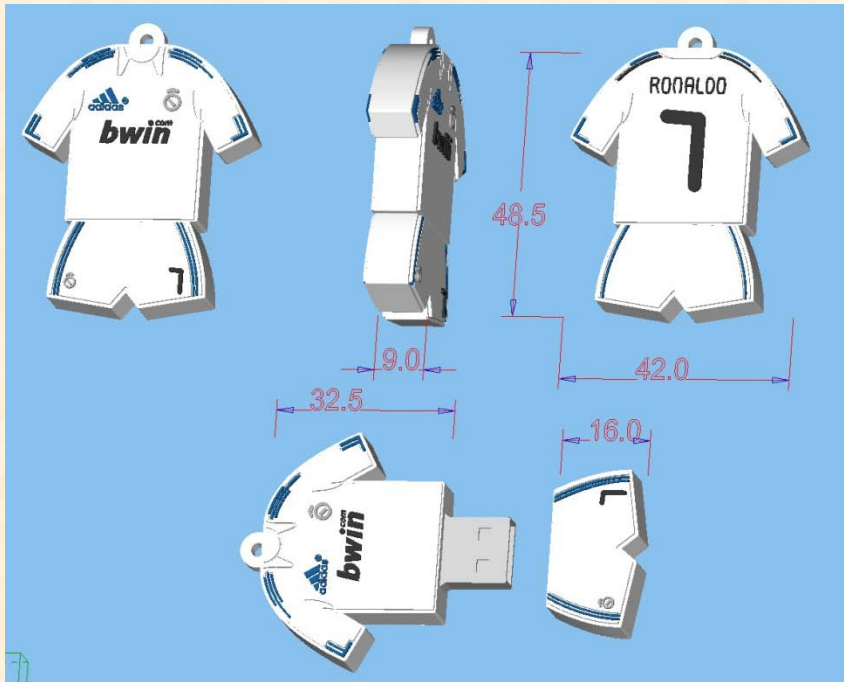

DESIGN CUSTOM
USB

100% Design Successfully casing

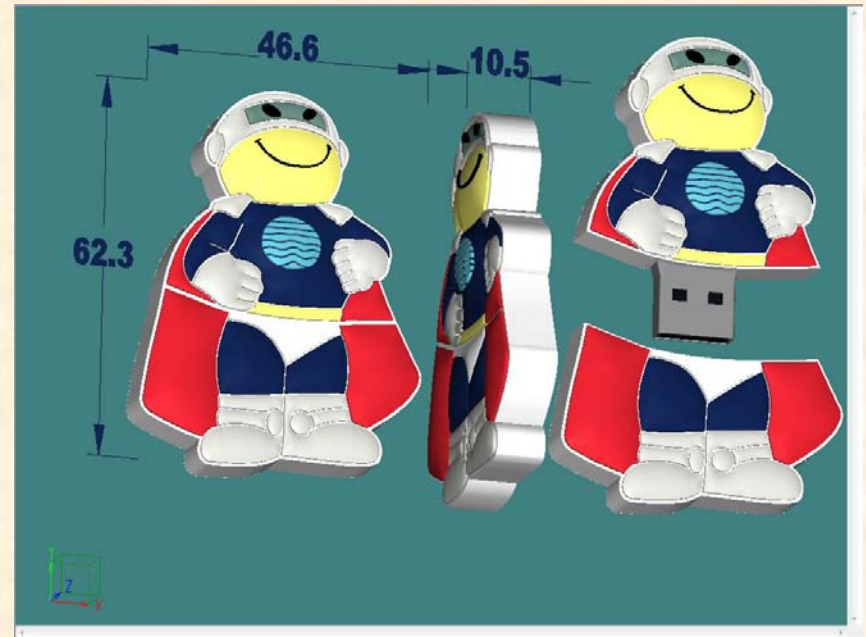
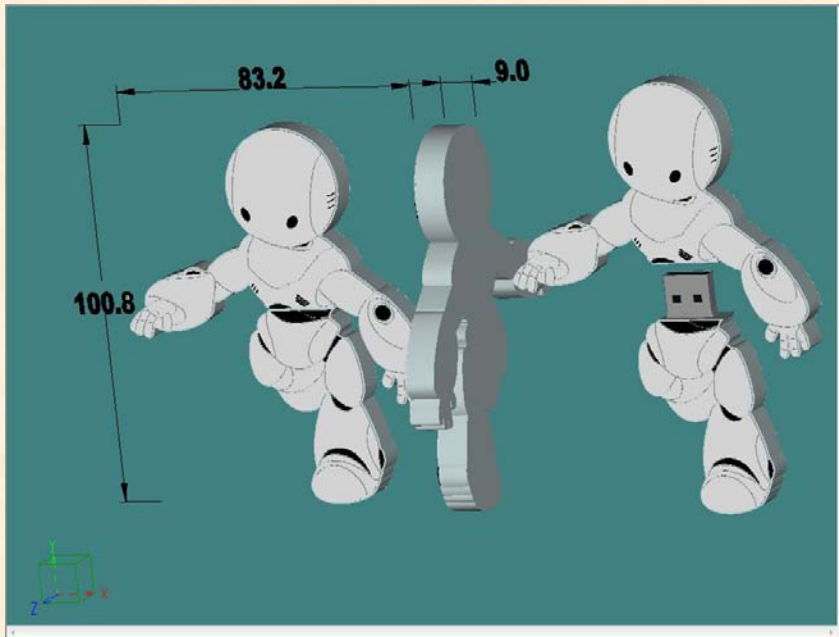

Thanks for watching!